



**MANILLA GAIA MP CON LLAVE**

GAIA MP LOCKABLE HANDLE / GAIA MP POIGNÉE AVEC CLÉ

REFERENCIA / REFERENCE / RÉFÉRENCE

APERTURAS / OPENING / OUVERTURES

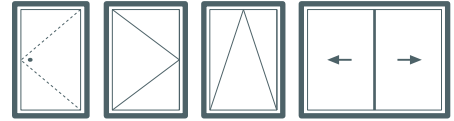

7CB 6400 \*\*





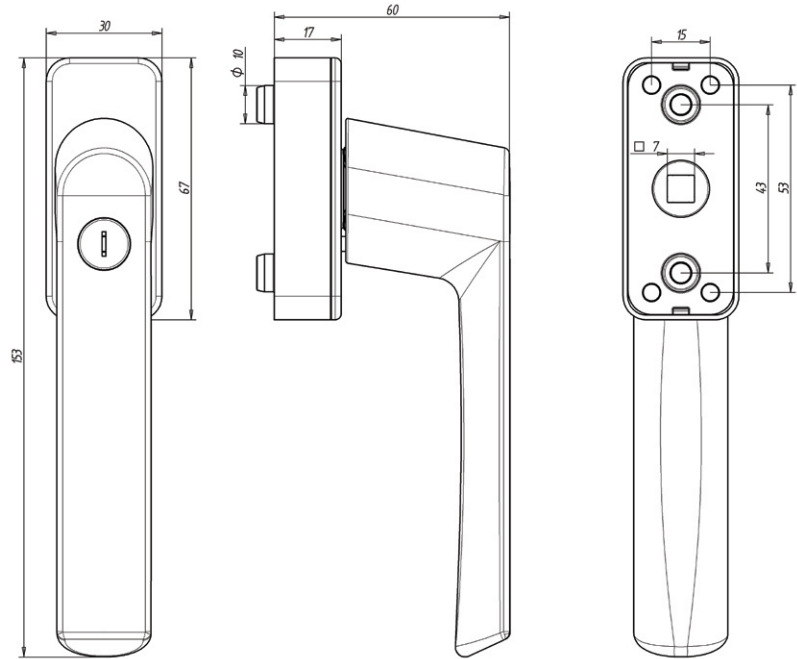
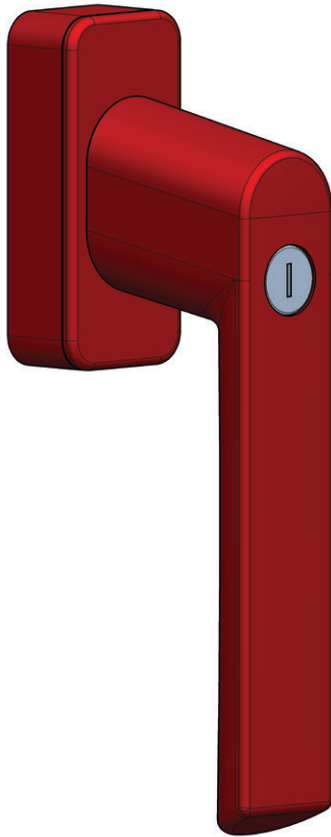

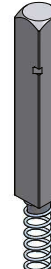



10 UD

Embolsada individualmente con protector. Se sirve por separado la tornillería y el cuadradillo. Individually bagged with protector. The screws and the square are served separately. Emballé individuellement avec protecteur. Les vis et l'équerre sont servies séparément.



	7CB 0002AS	CUADRADILLO CON MUELLE 7*50 + TORNILLOS
	7CB 0003AS	CUADRADILLO CON MUELLE 7*60 + TORNILLOS
	7CB 0004AS	CUADRADILLO CON MUELLE 7*70 + TORNILLOS

DESCRIPCIÓN	DESCRIPTION	DESCRIPTION
<ul style="list-style-type: none"> <li>Manilla reversible con bloqueo de la posición del asa mediante llave. Para aplicaciones con caja de transmisión o mecanismo similar.</li> <li>Para aperturas oscilo-batiente, practicable y corredera.</li> </ul>	<ul style="list-style-type: none"> <li>Reversible handle with handle position locked by key. For applications on gear box or similar mechanism.</li> <li>For tilt-and-turn, casement and sliding openings.</li> </ul>	<ul style="list-style-type: none"> <li>Poignée reversible avec verrouillage de la position de la poignée par clé. Pour les applications en boîte de transmission ou mécanisme similaire.</li> <li>Pour ouverture oscillo-battante, battante et coulissante.</li> </ul>
CARACTERÍSTICAS TÉCNICAS	TECHNICAL FEATURES	CARACTÉRISTIQUES TECHNIQUES
<ul style="list-style-type: none"> <li>Válida para perfiles de Aluminio y PVC.</li> <li>Fijación desde la parte delantera (Tornillos ocultos).</li> <li>Fijación directa al mecanismo y fijación adicional opcional al perfil.</li> <li>Distancia entre taladros de fijación: 43 mm.</li> <li>Dimensión del cuadradillo 7x7 mm.</li> </ul>	<ul style="list-style-type: none"> <li>Valid for Aluminum and PVC profiles.</li> <li>Fixing from the front (hidden screws).</li> <li>Direct fixing to the mechanism and optional additional fixing to the profile.</li> <li>Distance between mounting holes: 43 mm.</li> <li>Dimension of the square 7x7 mm.</li> </ul>	<ul style="list-style-type: none"> <li>Valable pour les profils en aluminium et en PVC.</li> <li>Fixation par l'avant (vis cachées).</li> <li>Fixation directe au mécanisme et fixation supplémentaire facultative au profilé.</li> <li>Distance entre les trous de montage : 43 mm.</li> <li>Dimension du carré 7x7 mm.</li> </ul>
MATERIALES / MATERIALS / MATÉRIAUX	ATRIBUTOS / FEATURES / ATTRIBUTS	TRATAMIENTOS / TREATMENTS / TRAITEMENTS
<p>Tornillería Screws Vis</p> <p><b>INOX AU</b></p> <p>Piezas de plástico Plastic pieces Pièces de plastique</p> <p><b>PO</b></p> <p>Piezas Pieces Pièces</p> <p><b>ZMK 5</b></p> <p>Manilla Handle Béquille</p> <p><b>AL</b></p>	<p> Montaje rápido Quick assembly Montage rapide</p> <p> Con llave With key À clé</p> <p> Tecnología Protect</p> <p>Possibilidad de incluir cuadradillo retractil.</p>	<p> Vibrado Vibrated Vibré</p> <p> Zincado Zinc Zinc</p> <p> Pasivado Passivation Passivation</p> <p> Circonizado Zirconium Zirconium</p> <p> Polimerizado Polymerized Polimérisé</p>