

WWW.BAICHA.COM

INGENIERÍA INTELIGENTE
PARA VENTANAS Y PUERTAS
INTELLIGENT ENGINEERING
FOR WINDOWS AND DOORS
ENGENHARIA INTELIGENTE
PARA JANELAS E PORTAS

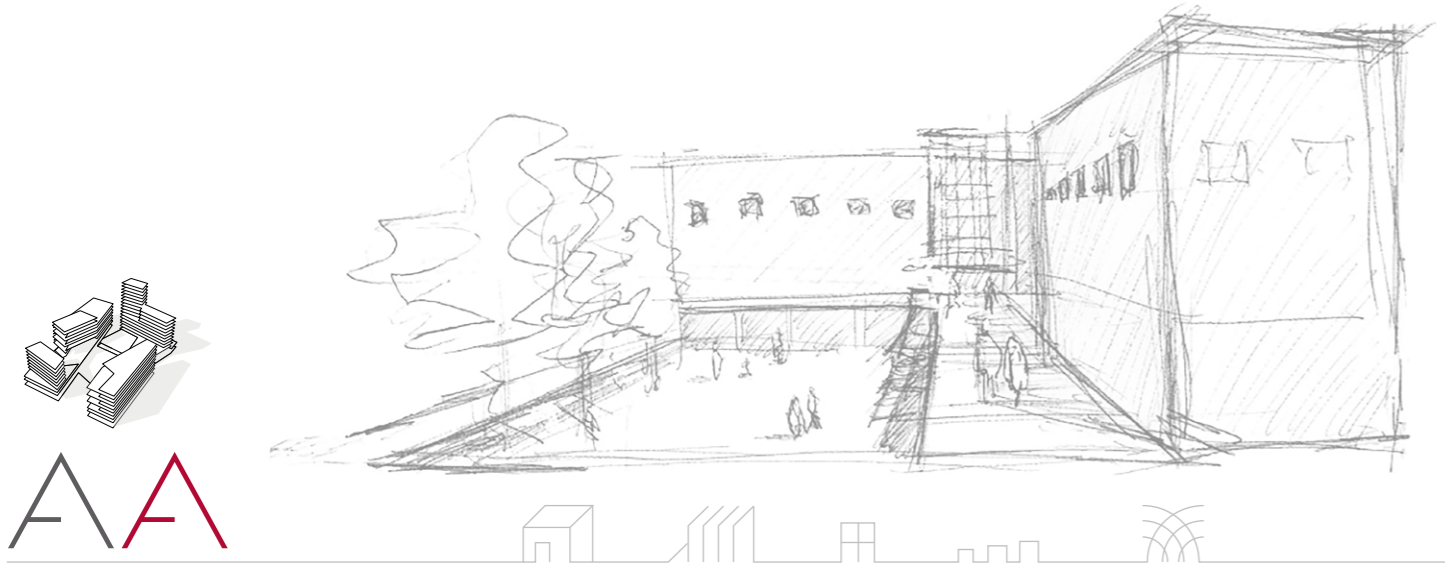

NUEVA GAMA GAIA
CREMONAS Y MANILLAS
PARA ALTA ARQUITECTURA

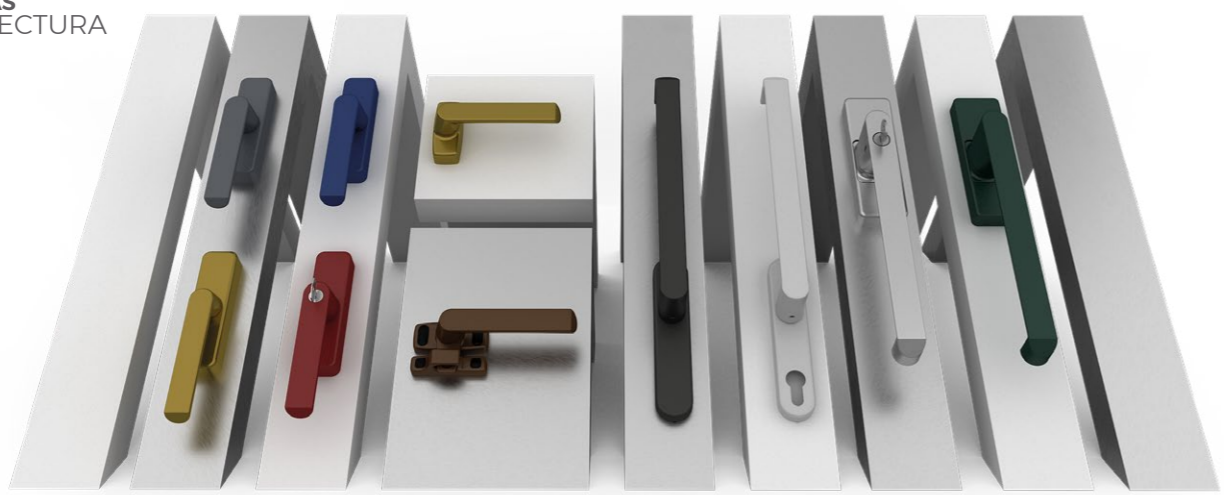

GAIA

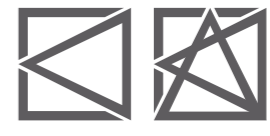

NUEVA LÍNEA DE
CREMONAS PARA
ALTA ARQUITECTURA

NEW LINE OF
CREMONS FOR
TOP ARCHITECTURE



BAICHA, S.L.U.
TEL +34 981 563 300 FAX +34 981 571 153
POLIG. DEL TAMBRE, VÍA EDISON 31 A_B
15890 SANTIAGO DE COMPOSTELA
A CORUÑA (SPAIN)
MAIL INFO@BAICHA.COM



CENTROS DISTRIBUCIÓN

ASTURIAS
TEL +34 985 267 503
POLIG. IND. SILVOTA, C/ PEÑA MAYOR 61-C
33192 SILVOTA - LLANERA (ASTURIAS)

CANTABRIA
TEL +34 942 255 160
POLIG. IND. LA CERRADA, NAVE 14
39600 MALIAÑO (CANTABRIA)

PAÍS VASCO
TEL +34 945 128 766
POLIG. IND. BETOÑO, AVDA. CANTÁBRICO 12 PAB. 53
01013 VITORIA (ÁLAVA)



POSIBILIDAD APERTURAS | OPENING POSSIBILITIES

PR
PRACTICABLE
TILT ONLY

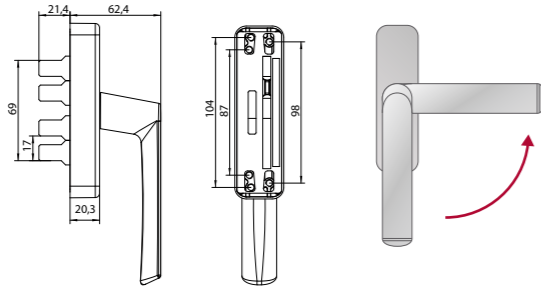

7CB6001**



APERTURAS Y BLOQUEOS POSIBLES | OPENINGS AND POSSIBLE BLOCKS

PR
PRACTICABLE
TILT ONLY

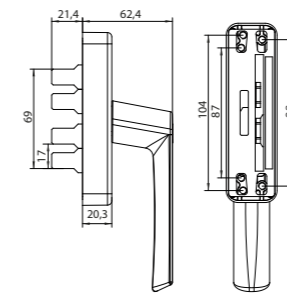

7CB611L** | 7CB611R**
LEFT (apertura izquierda) RIGHT (apertura derecha)

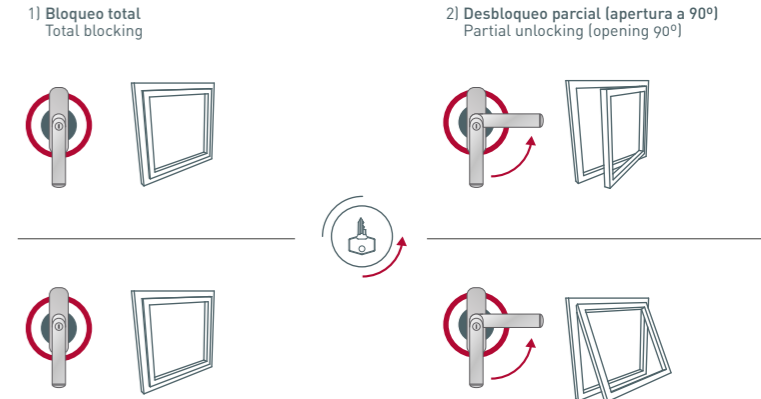

O3
OSCILO BATEANTE
TILT AND TURN

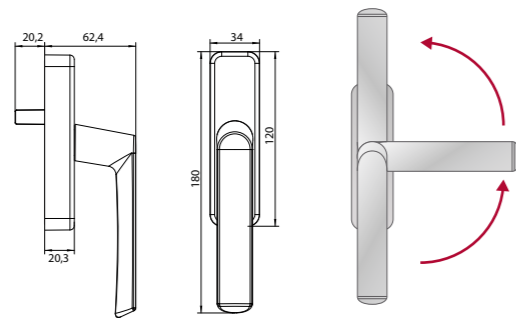

7CB6002**

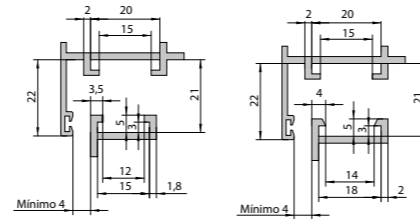

O3
OSCILO BATEANTE
TILT AND TURN

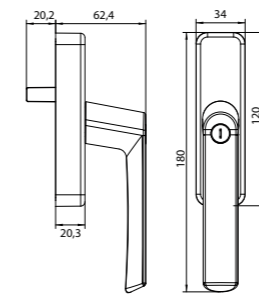

7CB612L** | 7CB612R**
LEFT (apertura izquierda) RIGHT (apertura derecha)

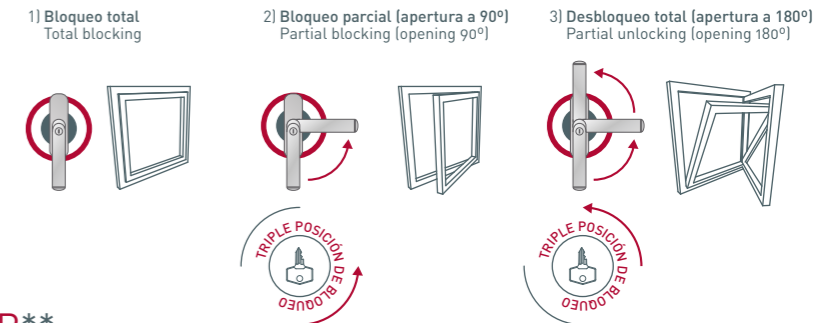

CARACTERÍSTICAS TÉCNICAS | TECHNICAL FEATURES

PR

- Válida para Series Convencionales (PR) y de Cámara Europea (PR).
- Fijación desde la parte trasera (tornillos ocultos).
- Distancias entre taladros de fijación: 87-98-104 mm.
- Dimensiones de las palas 10x3 mm.
- Recorrido de las palas 17 mm cada 90°.
- Valid for conventional Series (PR) and Euro Groove (PR).
- Backside fixing (hidden screws).
- Distance between fixing drills: 87-98-104 mm.
- Levers Size 10x3 mm.
- Levers opening 17 mm every 90°.

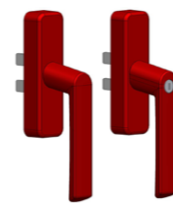

O3

- Válida para Series de Cámara Europea.
- Fijación desde la parte trasera (tornillos ocultos).
- Distancias entre taladros de fijación: 87-98-104 mm.
- Dimensiones de las palas 10x3 mm.
- Recorrido de las palas 17 mm cada 90°.
- Valid for Euro Groove.
- Backside fixing (hidden screws).
- Distance between fixing drills: 87-98-104 mm.
- Levers Size 10x3 mm.
- Levers opening 17 mm every 90°.

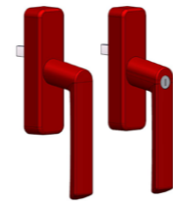

ACABADOS Y DISPONIBILIDAD | ACABADOS Y DISPONIBILIDAD



Servicio 24/48 h. para colores estándar. Cualquier RAL bajo pedido, en menos de 15 días.

Service 24/48 h. for standard colors. Any RAL upon request, in less than 15 days.



MATERIALES / MATERIALS	ATRIBUTOS / FEATURES	TRATAMIENTOS / TREATMENTS	COLORES ESTANDAR / STANDARD COLOURS
Tornillería Screws INOX AU Piezas de plástico Plastic pieces PO Piezas Pieces ZMK 5 Manilla Handle AL	Con llave With key CAJAS DE 10 UNIDADES Embolsada individualmente con tornillos de fijación 10 UNITS PACKAGE Individually packed with fixing screws.	Vibrado Vibrated Zincado Zinc Pasivado Passivation Circonizado Zirconium Polimerizado Polymerized	9010 Blanco mate Matt white 9011 Negro Mate Matt black Plata Silver ACABADOS ESPECIALES / SPECIAL FINISHES ORO PVD PVD bajo pedido PVD to order RAL bajo pedido RAL to order



Compatibles herrajes Baicha de apertura practicable, oscilobateante y proyectante. Compatible with Baicha fittings for tilt only, tilt-and-turn and awning openings.